

Kilovac S05LT - PC Mount Version Make & Break Load Switching

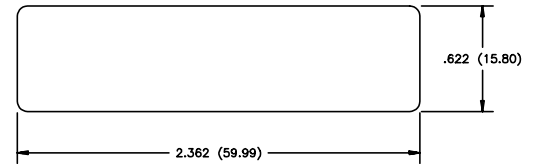
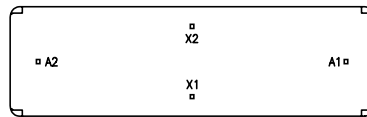
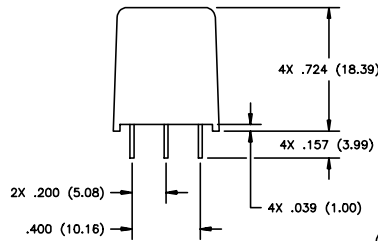
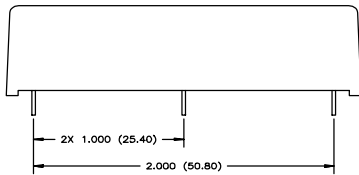
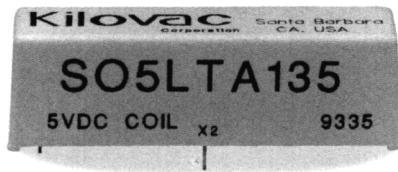

Features:

- Versatile 10kV, 5 amp carry relay
- Vacuum dielectric for power switching low current loads
- Widely used in test equipment applications
- Flying leads or PC mount available
- Very high service life

Kilovac S05LT - Flying Lead Version Make & Break Load Switching

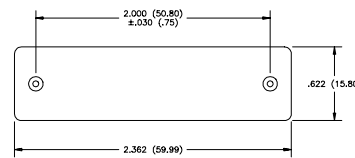
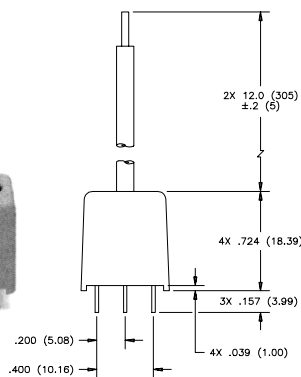

PIN VIEW/SCHEMATIC
(VIEWED FROM TOP OF RELAY)

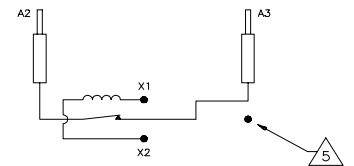

1. Overall dimensions are all maximums.
2. Dimensions in parentheses are in millimeters.
3. Pin dimensions tolerances are as follows:
Lengths: +/- .04 (1.0)
Spacing: +/- .006 (15)
4. Pins are .025 (0.6) square.
5. Coil terminals are polarity sensitive for the normally closed B version. X1 is positive, +, and X2 is negative -.

PRODUCT SPECIFICATIONS			
Part Number	Unit	S05LTA	S05LTB
Contact Arrangement		SPST-NO	SPST-NC
Contact Form		A	B
Voltage Ratings Between Contacts	kV Peak	10	10
Current Carry @ DC	Amps	5	5
Load Switching		See Chart Below	See Chart Below
Contact Resistance	Ohms	0.250	0.250
Contact Capacitance	pF		
Between Open Contacts		1	1
Closed Contacts to Ground		8	8
Operate and Release Time [6]	ms	2	2
Shock, 11 ms 1/2 Sine (Peak)	G's	100	100
Vibration	G's Peak	20	20
	Hz	10 to 500	10 to 500
Temperature Range	°C		
Operating		-20 to +70	-20 to +70
Storage		-35 to +110	-35 to +110
Initial Insulation Resistance	GigaOhms	10	10
Mechanical Life	Cycles	1 billion	1 billion
Weight, nominal	oz.	1	1

COIL DATA			
Nominal, Volts dc	5	12	24
Pickup, Volts dc, Maximum	6	15	28
Drop-Out, Volts dc	.5	2	4
Coil Resistance (Ohms ±10%)	28	150	780

PART NUMBER SELECTION					
Sample Part No.	S05LT	A	3	3	5
Contact Form		A = SPST-NO	B = SPST-NC		
Coil Voltage		1 = 5 Vdc	2 = 12 Vdc	3 = 24 Vdc	
High Voltage Connections		3 = Solder Connection	4 = 12" flying leads		
Mounting				5 = PC Covered	

Load Switching		Life in Cycles
Voltage	Current	
110 Vac	0.5 Amps	1,000,000
120 Vac	1.0 Amps	200,000
1000 Vac	200 mAmps	100,000
5000 Vac	83 mAmps	1,000